

Varenummer: 23110111044

Beskrivelse: E+G Vertikal oliestandsglas
HCK.381-GL-M12, for glycol-baserede løsninger

Mål

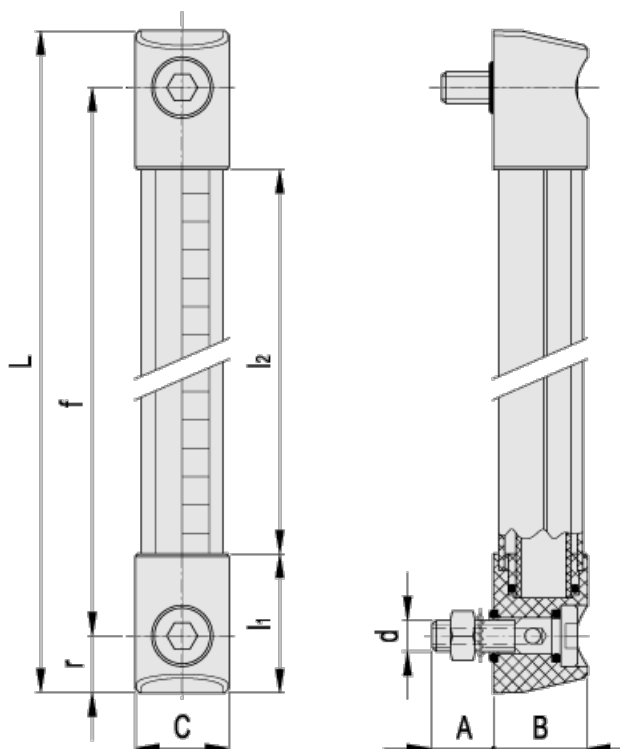

A = 20

r = 18.5

B = 33

C = 33

d = M12

f = 381

L = 418

l1 = 46.5

l2 = 325